



AC Load
- 2 A / 240 V

- Optically isolated
- Low on-state resistance
- Low input power consumption
- TTL and CMOS compatible
- RC networks (V AC)
- MOSFET output thyristor (V DC)
- Recognitions, certificates, directives: RoHS, 

Type of relay ① ②	D05-A1-24-020-1	D12-A1-24-020-1	D24-A1-24-020-1
Input circuit			
Nominal voltage	5 V DC	12 V DC	24 V DC
Control voltage range	3...10 V DC	7...20 V DC	18...32 V DC
Max. control current	12 mA	10 mA	7,7 mA
Release voltage	1,0 V DC	1,0 V DC	1,0 V DC
Input resistance	320 Ω	1,07 kΩ	3,0 kΩ
Output circuit			
Nominal load current		1 A AC see Fig.	
Max. load current		2 A AC see Fig.	
Nominal load voltage		rest condition: 240 V AC	
Load voltage range		12...280 V AC	
Non-repetitive peak voltage		rest condition: 600 V AC	
Non-repetitive surge current		operating state: 80 A	
Max. off-state leakage current		rest condition: 1,5 mA	
Max. on-state voltage drop		operating state: 1,2 V	
Min. load current		operating state: 50 mA	
Off-state dV/dt		max. allowable rate of voltage rise: 500 V/μs	
Operating frequency range		47...400 Hz	
RC snubber		10 nF, 100 Ω	
General data			
Output circuit switching moment		R ④	
Max. turn-on time		100 μs ⑤	
Max. turn-off time		1/2 cycle + 1 ms ⑤	
Insulation dielectric strength		between input and output: 4 000 V AC 1 minute	
Dimensions (L x W x H)		28 x 5 x 15 mm	
Weight		4 g	
Storage temperature		-40...+100 °C	
Operating temperature		-20...+80 °C rated value: +55 °C see Fig.	
Max. solder bath temperature		220 °C 10 s	

Load current in the function of the ambient temperature and distances between relays

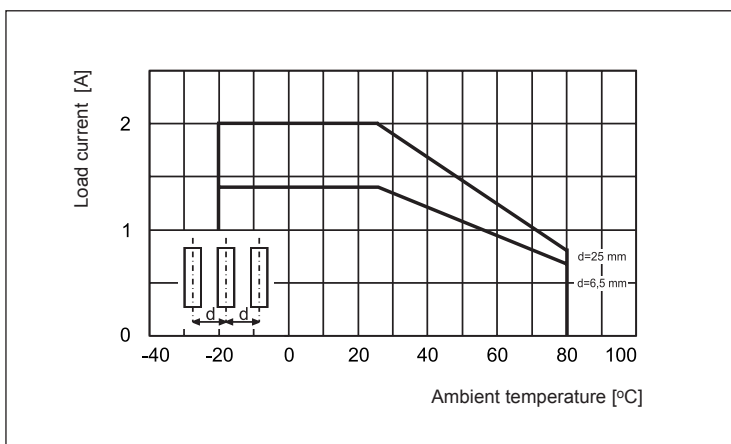

Dimensions, mounting openings raster, ordering codes - see page 14

- ① The data in bold type pertain to the standard versions of the relays.
- ② Basic technical data at 20 °C
- ④ R - instantaneous switching of the output circuit
- ⑤ At rated voltage

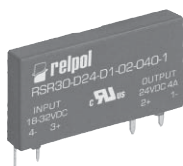

DC Load
- 2,5 A / 48 V

- **Applications:** household appliances, temperature control system, industrial automatic control, light system, office appliances, factory appliances
- **Mounting:** relays RSR30 are designed for direct PCB mounting, single in line package

Type of relay ① ②	D05-D1-04-025-1	D12-D1-04-025-1	D24-D1-04-025-1	D48-D1-04-025-1
Input circuit				
Nominal voltage	5 V DC	12 V DC	24 V DC	48 V DC
Control voltage range	3...10 V DC	7...20 V DC	18..32 V DC	38..58 V DC
Max. control current	12 mA	10 mA	7,7 mA	4,4 mA
Release voltage	1,8 V DC	3,6 V DC	8,3 V DC	8,3 V DC
Input resistance	320 Ω	1,07 kΩ	3,0 kΩ	10,8 kΩ
Output circuit				
Nominal load current	1 A DC see Fig.			
Max. load current	2,5 A DC see Fig.			
Nominal load voltage	rest condition: 48 V DC			
Load voltage range	0..60 V DC			
Non-repetitive peak voltage	rest condition: 100 V DC			
Non-repetitive surge current	operating state: 6 A			
Max. off-state leakage current	rest condition: 1 mA			
Max. on-state voltage drop	operating state: 0,4 V			
Min. load current	operating state: 1 mA			
Operation resistance	operating state: 160 mΩ ③			
Peak power dissipation	600 W			
Operating switching frequency	10 Hz			
Transient voltage suppressor	Yes			
Max. voltage of suppressor operation	60 V DC			
General data				
Output circuit switching moment	R ④			
Max. turn-on time	50 μs ⑤			
Max. turn-off time	600 μs ⑤			
Insulation dielectric strength	between input and output: 3 750 V AC 1 minute			
Dimensions (L x W x H)	28 x 5 x 15 mm			
Weight	4 g			
Storage temperature	-25...+100 °C			
Operating temperature	-20...+80 °C rated value: +55 °C see Fig.			
Max. solder bath temperature	220 °C 10 s			

Load current in the function of the ambient temperature and distances between relays

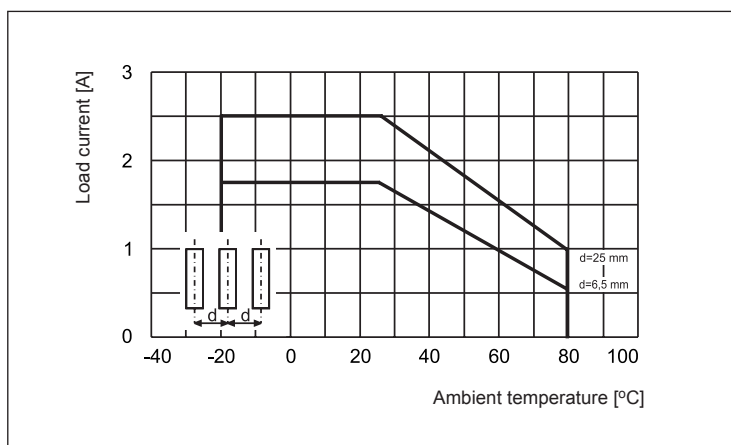

Dimensions, mounting openings raster, ordering codes - see page 14

- ① The data in bold type pertain to the standard versions of the relays.
- ② Basic technical data at 20 °C
- ④ R - instantaneous switching of the output circuit
- ⑤ At rated voltage
- ⑥ At rated current



DC Load
- 4 A / 24 V

Type of relay ① ②	D05-D1-02-040-1	D12-D1-02-040-1	D24-D1-02-040-1	D48-D1-02-040-1
Input circuit				
Nominal voltage	5 V DC	12 V DC	24 V DC	48 V DC
Control voltage range	3...10 V DC	7...20 V DC	18..32 V DC	38..58 V DC
Max. control current	12 mA	10 mA	7,7 mA	4,4 mA
Release voltage	1,8 V DC	3,6 V DC	8,3 V DC	8,3 V DC
Input resistance	320 Ω	1,07 kΩ	3,0 kΩ	10,8 kΩ
Output circuit				
Nominal load current	2 A DC see Fig.			
Max. load current	4 A DC see Fig.			
Nominal load voltage	rest condition: 24 V DC			
Load voltage range	0...32 V DC			
Non-repetitive peak voltage	rest condition: 60 V DC			
Non-repetitive surge current	operating state: 6 A			
Max. off-state leakage current	rest condition: 1 mA			
Max. on-state voltage drop	operating state: 0,24 V			
Min. load current	operating state: 1 mA			
Operation resistance	operating state: 120 mΩ			
Peak power dissipation	600 W			
Operating switching frequency	10 Hz			
Transient voltage suppressor	Yes			
Max. voltage of suppressor operation	36 V DC			
General data				
Output circuit switching moment	R ④			
Max. turn-on time	50 μs ⑤			
Max. turn-off time	600 μs ⑤			
Insulation dielectric strength	between input and output: 3 750 V AC 1 minute			
Dimensions (L x W x H)	28 x 5 x 15 mm			
Weight	4 g			
Storage temperature	-25...+100 °C			
Operating temperature	-20...+80 °C rated value: +55 °C see Fig.			
Max. solder bath temperature	220 °C 10 s			

Load current in the function of the ambient temperature and distances between relays

Dimensions, mounting openings raster, ordering codes - see page 14

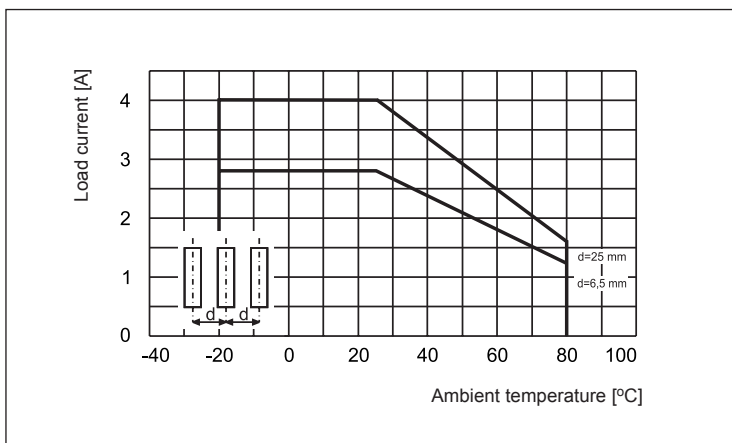

- ① The data in bold type pertain to the standard versions of the relays.
- ② Basic technical data at 20 °C
- ④ R - instantaneous switching of the output circuit
- ⑤ At rated voltage

 **NEW product**



DC Load
- 1 A / 100 V

Type of relay ① ②	D05-D1-24-010-1	D12-D1-24-010-1	D24-D1-24-010-1	D48-D1-24-010-1
Input circuit				
Nominal voltage	5 V DC	12 V DC	24 V DC	48 V DC
Control voltage range	3...10 V DC	7...20 V DC	18..32 V DC	38..58 V DC
Max. control current	12 mA	10 mA	7,7 mA	4,4 mA
Release voltage	1,8 V DC	3,6 V DC	8,3 V DC	8,3 V DC
Input resistance	320 Ω	1,07 kΩ	3,0 kΩ	10,8 kΩ
Output circuit				
Nominal load current	0,4 A DC see Fig.			
Max. load current	1 A DC see Fig.			
Nominal load voltage	rest condition: 100 V DC			
Load voltage range	0...180 V DC			
Non-repetitive peak voltage	rest condition: 180 V DC			
Non-repetitive surge current	operating state: 6 A			
Max. off-state leakage current	rest condition: 1 mA			
Max. on-state voltage drop	operating state: 0,6 V			
Min. load current	operating state: 1 mA			
Operation resistance	operating state: 1,5 Ω ⑦			
Peak power dissipation	600 W			
Operating switching frequency	10 Hz			
Transient voltage suppressor	Yes			
Max. voltage of suppressor operation	180 V DC			
General data				
Output circuit switching moment	R ④			
Max. turn-on time	50 μs ⑤			
Max. turn-off time	600 μs ⑤			
Insulation dielectric strength	between input and output: 2 500 V AC 1 minute			
Dimensions (L x W x H)	28 x 5 x 15 mm			
Weight	4 g			
Storage temperature	-25...+100 °C			
Operating temperature	-20...+80 °C rated value: +55 °C see Fig.			
Max. solder bath temperature	220 °C 10 s			

Load current in the function of the ambient temperature and distances between relays

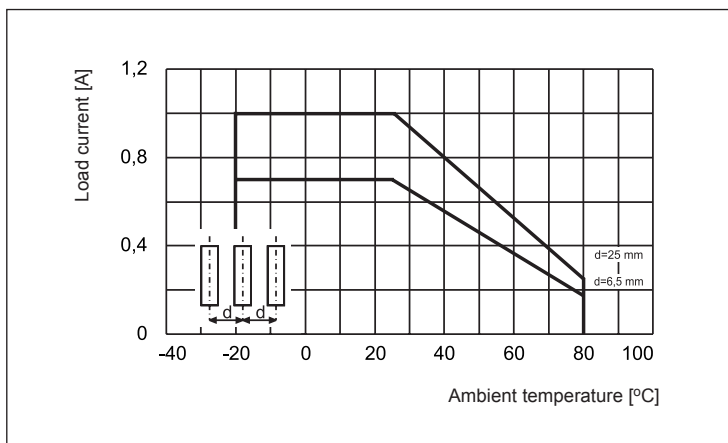

Dimensions, mounting openings raster, ordering codes - see page 14

- ① The data in bold type pertain to the standard versions of the relays.
- ② Basic technical data at 20 °C
- ④ R - instantaneous switching of the output circuit
- ⑤ At rated voltage
- ⑦ Maximum value

Dimensions

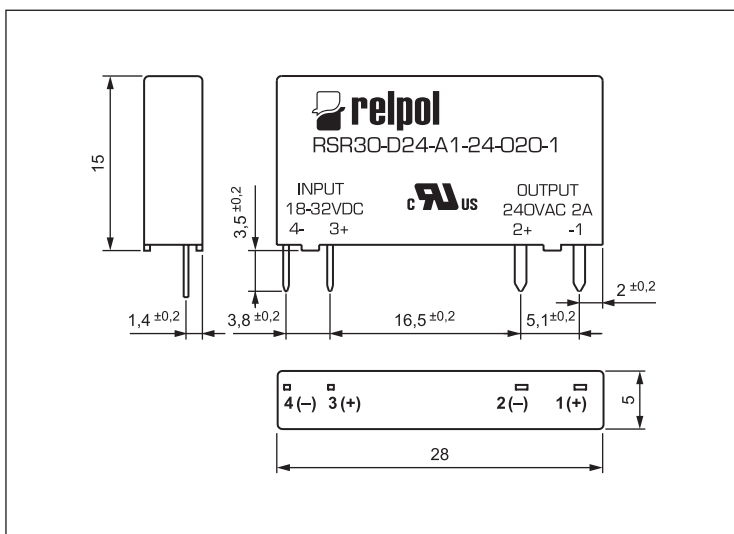

Mounting openings raster

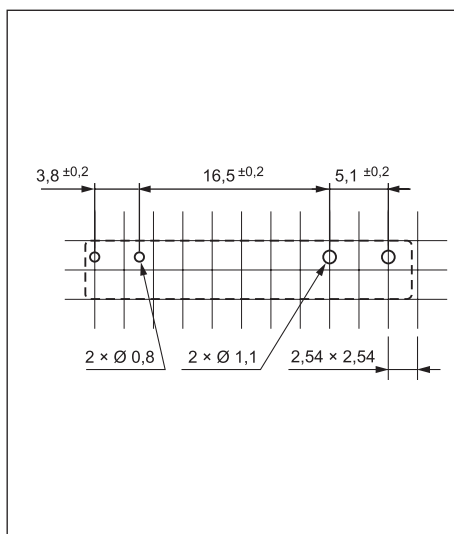

Ordering codes

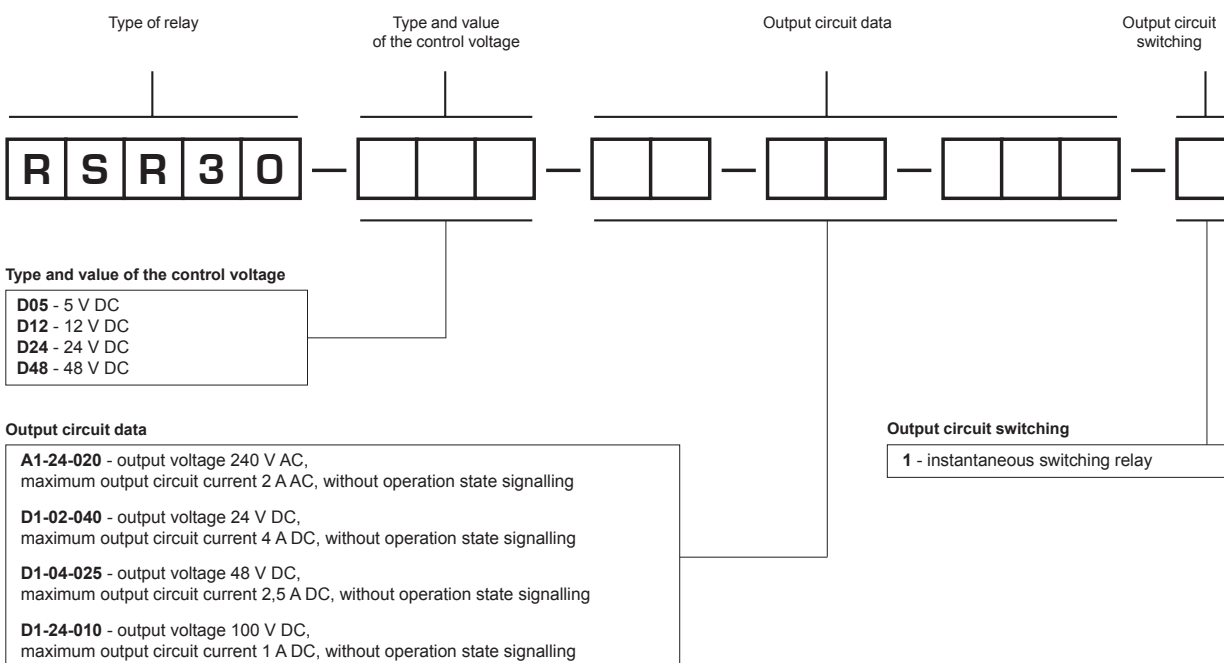

Example of ordering code:

RSR30-D12-D1-24-010-1 solid state relay **RSR30**, rated control voltage 12 V DC, rated voltage of output circuit - load 100 V DC, maximum output circuit current 1 A DC, without operation state signalling, instantaneous switching