

# PI85 with socket GZT80 interface relays

## RM85 + GZT80



- Interface relay **PI85 with socket GZT80** consists of:  
electromagnetic relay **RM85**, grey plug-in socket **GZT80**, signalling / protecting module **type M...**, retainer / retractor clip **GZT80-0040** (plastic), white description plate **GZT80-0035**
- 35 mm rail mount acc. to EN 60715 or on panel mounting with one M3 screw • May be linked with interconnection strip type **ZGGZ80**
- Recognitions, certifications, directives: recognitions RM85, RoHS,



### Contact data

Number and type of contacts		1 CO
Contact material		<b>AgNi</b> , AgNi/Au hard gold plating, AgSnO <sub>2</sub>
Rated / max. switching voltage	AC	250 V / 300 V
Min. switching voltage		5 V AgNi, 5 V AgNi/Au hard gold plating, 10 V AgSnO <sub>2</sub>
Rated load (capacity)	AC1	16 A / 250 V AC ①
	AC15	3 A / 120 V                      1,5 A / 240 V (B300)
	DC1	16 A / 24 V DC (see Fig. 3)
	DC13	0,22 A / 120 V                      0,1 A / 250 V (R300)
Motor load	acc. to UL 508	1/2 HP                      240 V AC, 4,9 FLA, single-phase motor ②
	AC3 acc. to IEC 60947-4-1	0,5 kW                      240 V AC, single-phase motor
Min. switching current		5 mA AgNi, 2 mA AgNi/Au hard gold plating, 10 mA AgSnO <sub>2</sub>
Max. inrush current		30 A
Rated current		16 A
Max. breaking capacity	AC1	4 000 VA
Min. breaking capacity		0,3 W AgNi, 0,05 W AgNi/Au hard gold plating, 1 W AgSnO <sub>2</sub>
Contact resistance		≤ 100 mΩ
Max. operating frequency	• at rated load	600 cycles/hour
	• no load	72 000 cycles/hour

### Coil data

Rated voltage	50/60 Hz AC	12, <b>24</b> , 48, 120, <b>230</b> , 240 V
	DC	12, <b>24</b> , 48, 110 V
Must release voltage		AC: ≥ 0,15 U <sub>n</sub> DC: ≥ 0,1 U <sub>n</sub>
Operating range of supply voltage		see Tables 1, 2 and Fig. 4, 5
Rated power consumption	AC	0,75 VA
	DC	0,4 ... 0,48 W

### Insulation according to EN 60664-1

Insulation rated voltage		250 V AC
Rated surge voltage		4 000 V    1,2 / 50 μs
Overtoltage category		III
Insulation pollution degree		3
Dielectric strength	• between coil and contacts	5 000 V AC                      type of insulation: reinforced
	• contact clearance	1 000 V AC                      type of clearance: micro-disconnection
Contact - coil distance	• clearance	≥ 10 mm
	• creepage	≥ 10 mm

### General data

Operating / release time (typical values)		7 ms / 3 ms
Electrical life	• resistive AC1	> 0,7 x 10 <sup>5</sup> 16 A, 250 V AC
	• cosφ	see Fig. 2
	• DC L/R=40 ms	> 10 <sup>5</sup> 0,12 A, 220 V DC
Mechanical life (cycles)		> 3 x 10 <sup>7</sup>
Dimensions (L x W x H)		80 x 15,6 x 67 mm
Weight		61 g
Ambient temperature	• storage	-40...+85 °C
	(non-condensation and/or icing)    • operating	AC: -40...+70 °C                      DC: -40...+85 °C
Cover protection category		IP 20                      EN 60529
Environmental protection		RM85: RTII                      GZT80: RT0                      EN 61810-7
Shock resistance		30 g
Vibration resistance		10 g 10...150 Hz

The data in bold type relate to the standard versions of the relays. ① Loads above 12 A require bridging pairs of screw terminals: 11 with 21, 12 with 22, 14 with 24 - see page 2. ② For single phase motors for 110-120 V AC do not use motors with higher FLA than given for 240 V AC.

# PI85 with socket GZT80 interface relays

## Dimensions

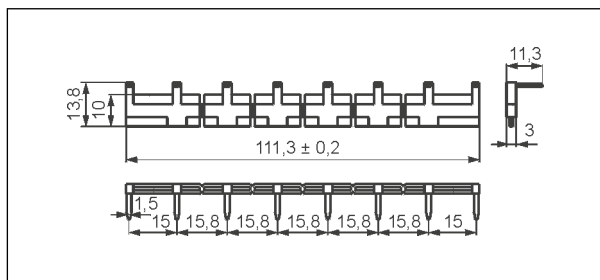
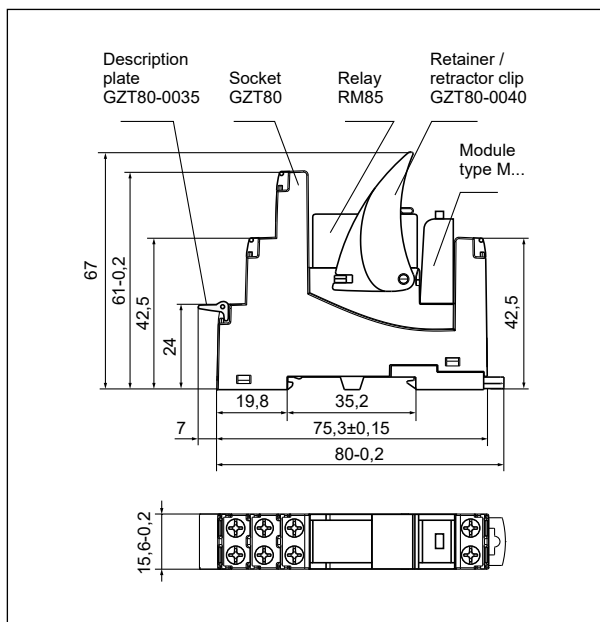

Interconnection strip type **ZGGZ80**

## Connection diagrams (screw terminals side view)

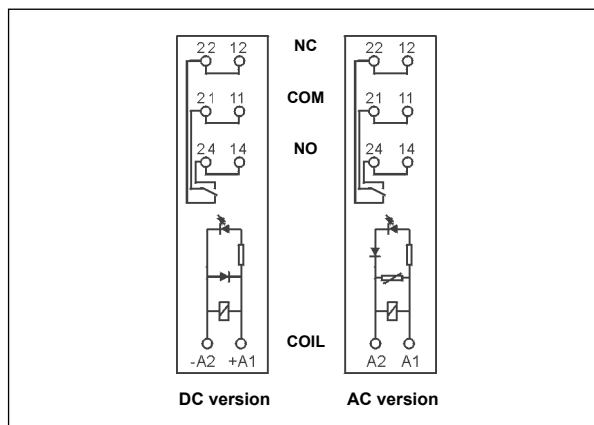

## Connection of GZT80 socket

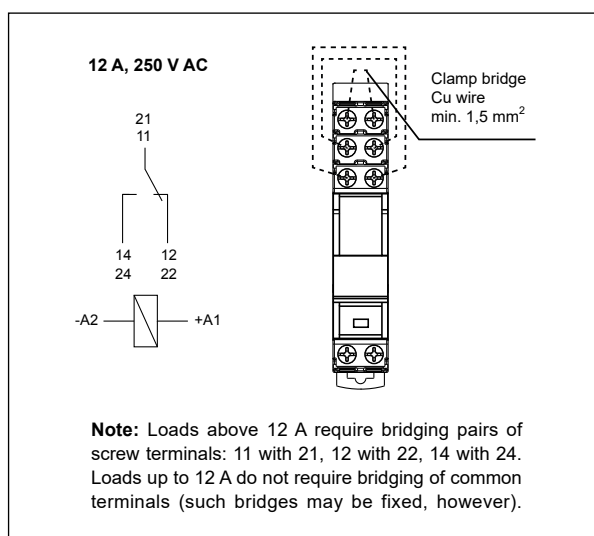

## Mounting

Relays **PI85 with socket GZT80** are designed for direct mounting on 35 mm rail mount acc. to EN 60715 or on panel mounting with one M3 screw. **Connections:** max. cross section of the cables (stranded): 2 x 2,5 mm<sup>2</sup> (2 x 14 AWG), stripping length: 6,5 mm, max. tightening moment for the terminal: 0,7 Nm.

Plug-in sockets **GZT80** may be linked with interconnection strip type **ZGGZ80**. Strip **ZGGZ80** bridges common input signals, maximum permissible current is 10 A / 250 V AC. Possibility of connection of 8 sockets. Colours of strips: **ZGGZ80-1** grey, **ZGGZ80-2** black (see page 5).

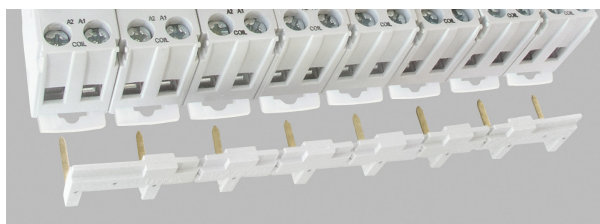

**Interconnection strip ZGGZ80:** bridging of common input signals.

## PRECAUTIONS:

1. Ensure that the parameters of the product described in its specification provide a safety margin for the appropriate operation of the device or system and never use the product in circumstances which exceed the parameters of the product. 2. Never touch any live parts of the device. 3. Ensure that the product has been connected correctly. An incorrect connection may cause malfunction, excessive heating or risk of fire. 4. In case of any risk of any serious material loss or death or injuries of humans or animals, the devices or systems shall be designed so to equip them with double safety system to guarantee their reliable operation.

**Electrical life at AC resistive load.**  
Switching frequency: 600 cycles/hour

Fig. 1

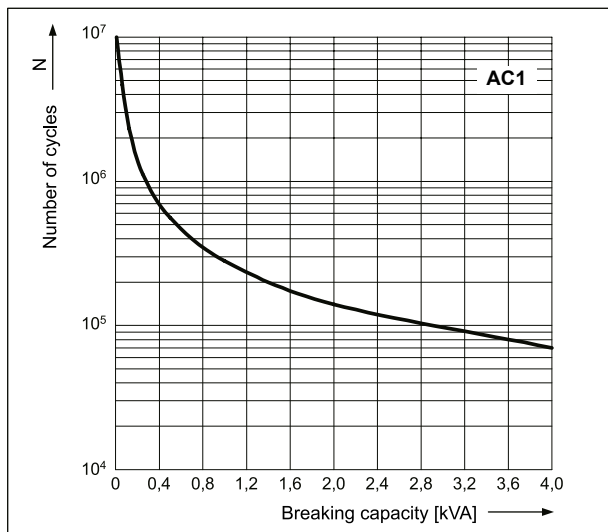

**Electrical life reduction factor at AC inductive load**

Fig. 2

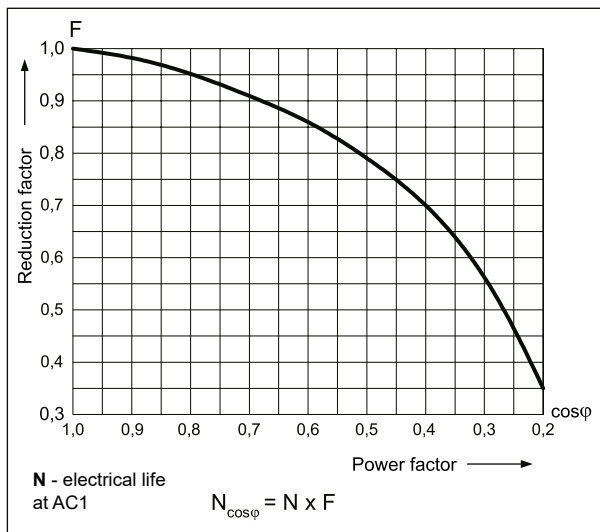

**Max. DC resistive load breaking capacity**

Fig. 3

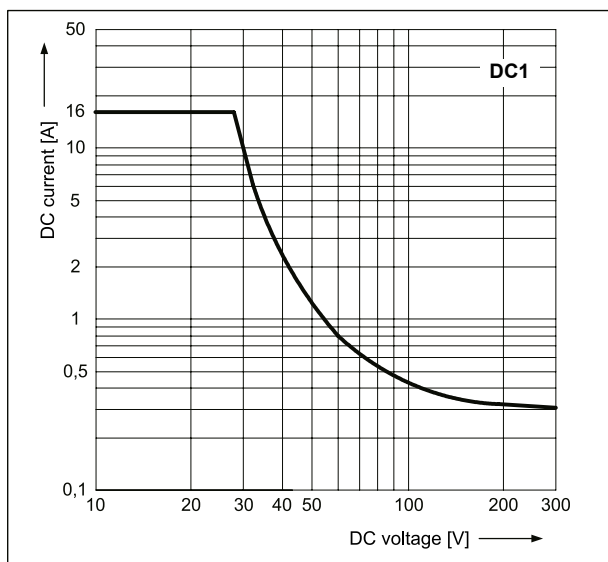

**Coil operating range - DC**

Fig. 4

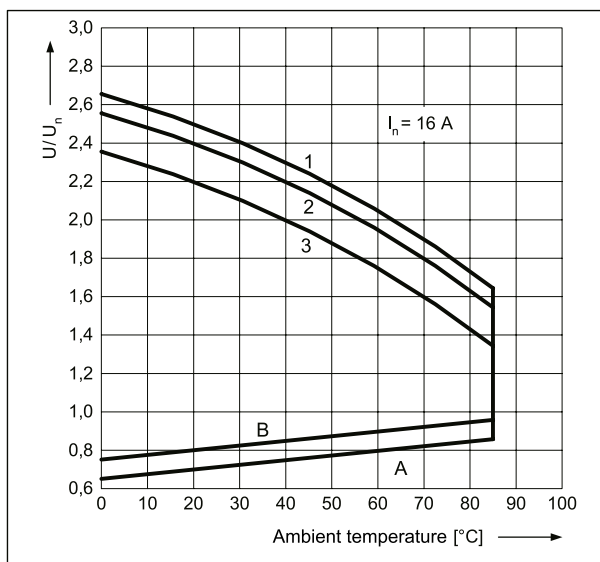

**Coil operating range - AC 50 Hz**

Fig. 5

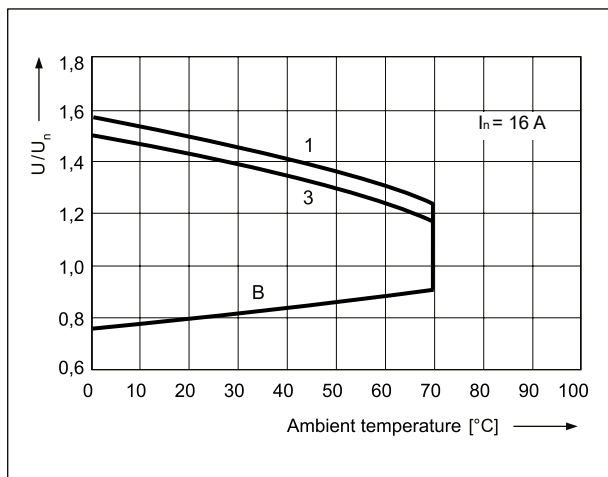

**Description of Fig. 4 and 5**

**A** - relations between make voltage and ambient temperature at no load on contacts. Coil temperature and ambient temperature are equal before coil energizing. Make voltage is not higher than the value read on Y axis (multiplication of rated voltage).

**B** - relations between make voltage and ambient temperature after initial coil heating up with  $1,1 U_n$ , at continues load of  $I_n$  on contacts. Make voltage is not higher than the value read on Y axis (multiplication of rated voltage).

**1, 2, 3** - values on Y axis represent allowed overvoltage on coil at certain ambient temperature and contact load:

- 1** - no load
- 2** - 50% of rated load
- 3** - rated load



## Interconnection strips ZGGZ80



PI85-...-MS-...  
(RM85 + GZM80)

ZGGZ80

### ZGGZ80 for:

Plug-in sockets	Relays for plug-in sockets	Interface relays <sup>1</sup>
GZT80	RM84, RM85, RM85 inrush, RM85 105 °C sensitive, RM87L <sup>2</sup> , RM87P <sup>2</sup> , RM87N <sup>2</sup>	PI84-...-TS-... (RM84 + GZT80)
GZM80		PI84-...-MS-... (RM84 + GZM80)
GZS80		PI85-...-TS-... (RM85 + GZT80)
GZT92		(RM85 inrush + GZT80)
GZM92		PI85-...-MS-... (RM85 + GZM80)
GZS92		
ES 32	RM96 1 CO	

<sup>1</sup> Interface relay PI84 (PI85) is offered as a set: plug-in socket GZT80 or GZM80 + miniature relay RM84 (RM85) + signalling / protecting module type M... + retainer / retractor clip GZT80-0040 + description plate GZT80-0035. <sup>2</sup> Also versions RM87. sensitive

### Interconnection strip ZGGZ80

- designed for the co-operation with plug-in sockets of miniature relays and with interface relays PI84 and PI85, which are equipped with screw terminals; sockets and relays are mounted on 35 mm rail mount acc. to EN 60715,
- bridges common input signals (coil terminals A1 or A2) or output signals - see photo at the top,
- maximum permissible current is 10 A / 250 V AC,
- possibility of connection of 8 sockets or relays,
- colours of strips: **ZGGZ80-1** grey, **ZGGZ80-2** black.

