

# Plug-in sockets and accessories

## GZY2G

For RY2

Screw terminals  
Max. tightening moment  
for the terminal: 0,7 Nm  
35 mm rail mount  
acc. to EN 60715  
or on panel mounting  
78,7 x 28 x 32,4 mm  
Two poles  
12 A, 250 V AC



### Connection diagram

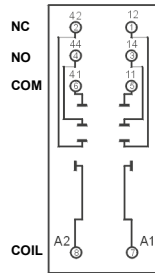

GZY2G-0041

### Dimensions

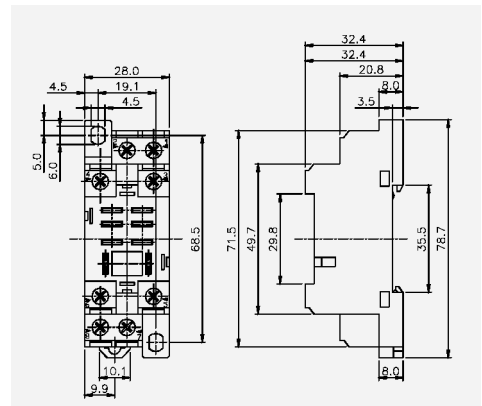

### Accessories

## GZ2

For R2M

Screw terminals  
Max. tightening moment  
for the terminal: 0,7 Nm  
35 mm rail mount  
acc. to EN 60715  
or on panel mounting  
65,2 x 20 x 25 mm  
Two poles  
7 A, 250 V AC

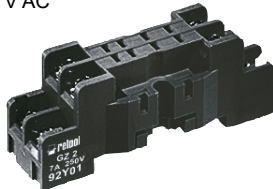

### Connection diagram

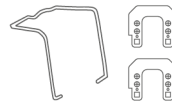
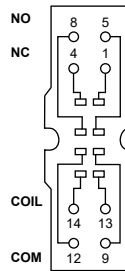

GZ2 1060

### Dimensions

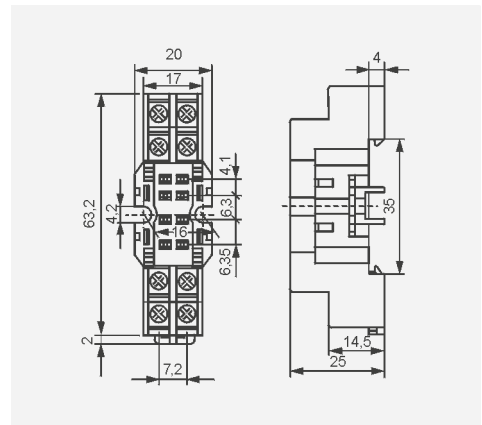

### Accessories

## S2M

For R2M

For PCB  
29,6 x 14 x 10,5 mm  
Two poles  
5 A, 250 V AC

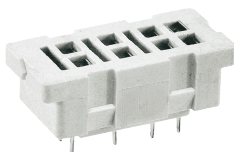

### Pinout

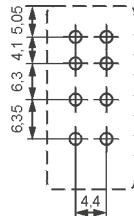

G4 1050

### Dimensions

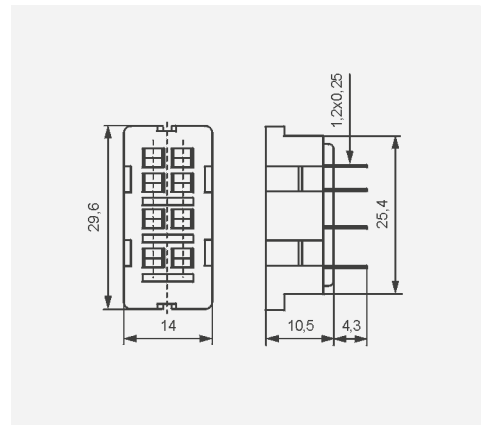

### Accessories

## G2M

For R2M

Solder terminals  
40,5 x 14 x 10,5 mm  
Two poles  
5 A, 250 V AC

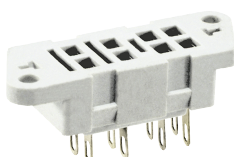

### Accessories



G4 1050



G2M 1020

### Dimensions

